



<b>F-05光纤连接器</b> <b>F-05 Connectors for Plastic Optical Fiber (POF*)</b>		
简图/Dimension	描述 / Description	Art.-No.
	单锁片金属头 用于 1/2.2mm POF*, 压接  Toslink Gold plug with single lock For 1/2.2mm POF*, crimping	F051000A1
	双锁片塑料头 (粉色/黑色/白色) 用于 1/2.2mm POF*, 压接  Toslink plastic plug with double lock (Pink/Black/White) For 1/2.2mm POF*, crimping	F051000A2
	双锁片金属头 用于 1/2.2mm POF*, 压接  Toslink Gold plug with double lock For 1/2.2mm POF*, crimping	
	Mini单锁头 用于 1/2.2mm POF*, 压接  Mini Toslink Gold plug with single lock For 1/2.2mm POF*, crimping	MF051000A1
	高端音频连接器 (塑料头/金属头) 用于 1/2.2* 5.5mm POF*, 粘贴  High High Quality Toslink Plug (Gold/Plastic) For 1/2.2* 5.5mm POF*, pasting	F051000A3

所有组件都可以提供固定式防尘帽/All assemblies can be supplied with captive dust protection caps.

根据要求提供其他版本/Other versions on request

\*POF=聚合物/\*POF=Polymer

F-05光纤连接器 F-05 Connectors for POF&HPCS		
简图/Dimension	描述 / Description	Art.-No.
	TOCP 155,单工, 用于 980/1000um POF*, 压接  TOCP 155, Simplex, For 980/1000um POF*, crimping	F051000A4
	TOCP 172,单工, 用于 980/1000um POF*, 压接  TOCP 172, Simplex, For 980/1000um POF*, crimping	F051000A5
	CF-1571,单工, 用于200/230um HPCS*, 粘贴  CF-1571, Simplex, For 200/230mm HPCS*, pasting	F05200230A1
	CF-1501,单工, 用于200/230um HPCS*, 粘贴  CF-1501, Simplex, For 200/230mm HPCS*, pasting	F05200230A2
	TOCP 151,单工, 用于200/230um HPCS*, 粘贴  TOCP 151, Simplex, For 200/230mm HPCS*, pasting	F05200230A3

所有组件都可以提供固定式防尘帽/All assemblies can be supplied with captive dust protection caps.

根据要求提供其他版本/Other versions on request

\*POF=聚合物/\*POF=Polymer

F-05光纤连接器 F-05 Connectors for POF&HPCS		
简图/Dimension	描述 / Description	Art.-No.
	TOCP 100,单工, 用于 980/1000um POF*, 压接  TOCP 100, Simplex, For 980/1000um POF*, crimping	F051000A6
	TOCP 100,单工, 用于200/230um HPCS*, 粘贴  TOCP 100, Simplex, For 200/230mm HPCS*, pasting	F05200230A4
	CF-1001,单工, 用于200/230um HPCS*, 粘贴  CF-1001, Simplex, For 200/230mm HPCS*, pasting	F05200230A5
	CF-1071,单工, 用于200/230um HPCS*, 粘贴  CF-1071, Simplex, For 200/230mm HPCS*, pasting	F05200230A6
	CA7103 ,单工, 用于200/230um HPCS*, 粘贴  CA7103, Simplex, For 200/230mm HPCS*, pasting	F05200230A7
	SGK S01-L1 ,单工, 用于200/230um HPCS*, 粘贴  SGK S01-L1, Simplex, For 200/230mm HPCS*, pasting	F05200230A8

所有组件都可以提供固定式防尘帽/All assemblies can be supplied with captive dust protection caps.

根据要求提供其他版本/Other versions on request

\*POF=聚合物/\*POF=Polymer

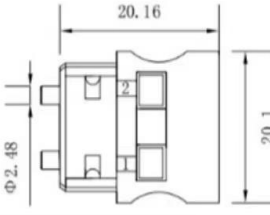
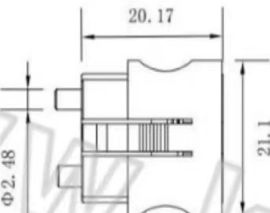
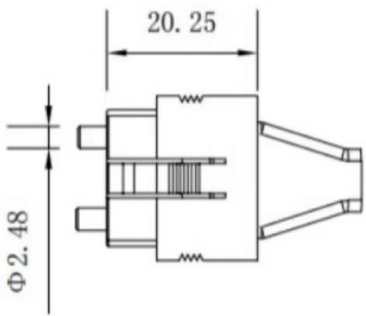
F-07光纤连接器 F-07 Connectors for POF& HPCS		
简图/Dimension	描述 / Description	Art.-No.
	<p>F07伺服,双工, 用于 980/1000um POF*, 压接</p> <p>F07 Servo, Duplex, For 980/1000um POF*, crimping</p>	F071000B1
	<p>F07伺服,双工, 用于 980/1000um POF*, 压接</p> <p>AMP F07, Duplex, For 980/1000um POF*, crimping</p>	F071000B2
	<p>F07伺服,双工, 用于 200/230 um HPCS*, 粘贴</p> <p>AMP F07, Duplex, For 200/230 um HPCS*, pasting</p>	F07200230B1
	<p>Toep 200,双工, 用于 980/1000um POF*, 压接</p> <p>Toep 200, Duplex, For 980/1000um POF*, crimping</p>	F071000B3
	<p>Toep 200,双工, 用于 200/230 um HPCS*, 粘贴</p> <p>Toep 200, Duplex, For 200/230 um HPCS*, pasting</p>	F07200230B2
	<p>TOCP 201 QK, 双工, 用于 200/230 um HPCS*, 粘贴</p> <p>TOCP 201 QK duplex, Duplex, For 200/230 um HPCS*, pasting</p>	F07200230B3
	<p>CF-2001,双工 用于 200/230um HPCS*,粘贴</p> <p>CF-2001 QK duplex, Duplex, For 200/230 um HPCS*, pasting</p>	F07200230B4

所有组件都可以提供固定式防尘帽/All assemblies can be supplied with captive dust protection caps.  
根据要求提供其他版本/Other versions on request

\*POF=聚合物/\*POF=Polymer



F-07光纤连接器 F-07 Connectors for HPCS		
简图/Dimension	描述 / Description	Art.-No.
<p>The drawing shows a side view of the connector with a total length of 21.00 mm. The diameter of the main body is 2.48 mm (Φ2.48), and the height of the main body is 13.80 mm. The connector has a series of pins on one end and a corresponding socket on the other.</p>	F07 DL-72,双工, 用于 200/230 um HPCS*, 粘贴  F07 DL-72, Duplex, For 200/230 um HPCS*, pasting	F07200230B5
	CA7003 ,双工, 用于 200/230 um HPCS*, 粘贴  CA7003, Duplex, For 200/230 um HPCS*, pasting	F07200230B6
	SGK S01-L2 ,双工, 用于 200/230 um HPCS*, 粘贴  SGK S01-L2 , Duplex, For 200/230 um HPCS*, pasting	F07200230B7
	CA9003 ,双工, 用于 200/230 um HPCS*, 粘贴  CA9003, Duplex, For 200/230 um HPCS*, pasting	F07200230B8
	CF-2071 ,双工, 用于 200/230 um HPCS*, 粘贴  CF-2071, Duplex, For 200/230 um HPCS*, pasting	F07200230B9
	CF-2501 ,双工, 用于 200/230 um HPCS*, 粘贴  CF-2501, Duplex, For 200/230 um HPCS*, pasting	F07200230B10

所有组件都可以提供固定式防尘帽/All assemblies can be supplied with captive dust protection caps.

根据要求提供其他版本/Other versions on request

\*POF=聚合物/\*POF=Polymer

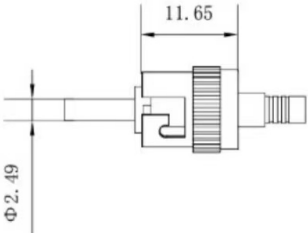
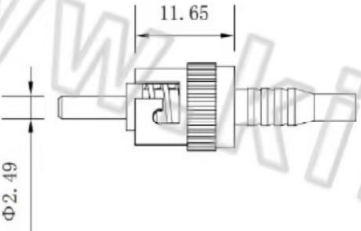
ST 光纤连接器 ST Connectors for POF& HPCS		
简图/Dimension	描述 / Description	Art.-No.
	ST 单工 用于200/230um HPCS*, 粘贴  ST Simplex, For 200/230mm HPCS*, pasting	KZST200230A1
	ST 单工 用于500um POF*, 压接  ST Simplex, For 500um POF*, crimping	KZST500A1
	ST 单工 用于750um POF*,压接  ST Simplex, For 750um POF*, crimpin	KZST750A1
	ST 单工 用于1000um POF*,压接  ST Simplex, For 1000um POF*, crimpin	KZST1000A1
	ST 单工 用于1500um POF*,压接  ST Simplex, For 1500um POF*, crimpin	KZST1500A1

有组件都可以提供固定式防尘帽/All assemblies can be supplied with captive dust protection caps.

根据要求提供其他版本/Other versions on request

\*POF=聚合物/\*POF=Polymer

FC光纤连接器 FC Connectors for POF& HPCS		
简图/Dimension	描述 / Description	Art.-No.
	<p>FC 单工 用于200/230um HPCS*, 粘贴</p> <p>FC Simplex, For 200/230um HPCS*, pasting</p>	KZFC200230A1
	<p>FC 单工 用于500um POF*, 压接</p> <p>FC Simplex, For 500um POF*, crimping</p>	KZFC500A1
	<p>FC 单工 用于750um POF*, 压接</p> <p>FC Simplex, For 750um POF*, crimping</p>	KZFC750A1
	<p>FC 单工 用于1000um POF*, 压接</p> <p>FC Simplex, For 1000um POF*, crimping</p>	KZFC1000A1
	<p>FC 单工 用于1500um POF*, 压接</p> <p>FC Simplex, For 1500um POF*, crimping</p>	KZFC1500A1

有组件都可以提供固定式防尘帽/All assemblies can be supplied with captive dust protection caps.

根据要求提供其他版本/Other versions on request

\*POF=聚合物/\*POF=Polymer

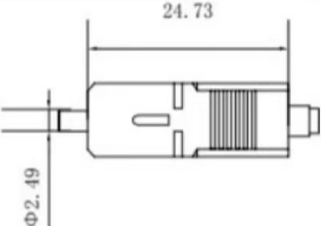
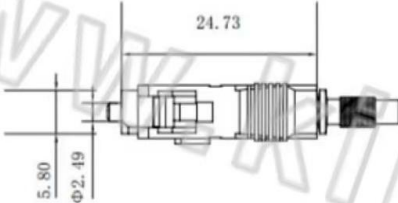
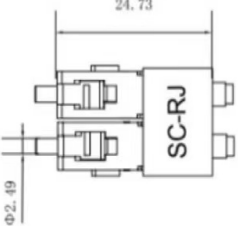
SC光纤连接器 SC Connectors for HPCS		
简图/Dimension	描述 / Description	Art.-No.
	SC 单工 用于200/230um HPCS*, 粘贴  SC Simplex, For 200/230mm HPCS*, pasting	KZSC200230A1
	SC 单工 用于500um POF*, 粘贴  SC Simplex, For 500um POF*, crimping or pasting	KZSC500A1
	SC 单工 用于750um POF*, 粘贴  SC Simplex, For 750um POF*, crimping or pasting	KZSC750A1
	SC 单工 用于1000um POF*, 粘贴  SC Simplex For 1000um POF*, crimping or pasting	KZSC1000A1
	SC 单工 用于1500um POF*, 粘贴  SC Simplex For 1500um POF*, crimping or pasting	KZSC1500A1
	SC-RJ 双工 用于1000um POF*, 粘贴  SC Duplex For 1000um POF*, crimping or pasting	KZSCRJ1000A1

有组件都可以提供固定式防尘帽/All assemblies can be supplied with captive dust protection caps.

根据要求提供其他版本/Other versions on request

\*POF=聚合物/\*POF=Polymer

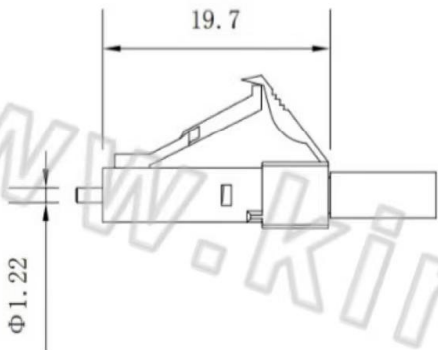
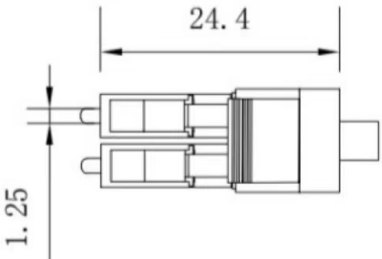
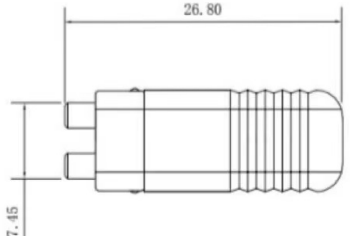
LC750-SMA905光纤连接器 LC750-SMA905 Connectors for POF& HPCS		
简图/Dimension	描述 / Description	Art.-No.
	LC 单工 用于 250um POF*, 压接  LC Simplex, For 250um POF*, crimping	KZLC250A1
	LC 单工 用于 500um POF*, 压接  LC Simplex, For 500um POF*, crimping	KZLC500A1
	LC 单工 用于 750um POF*, 压接  LC Simplex, For 750um POF*, crimping	KZLC750A1
	LC 双工 CC-Link 用于 50/125um POF*, 粘贴  LC Duplex CC-link for 50/125um POF*, crimping or pasting	KZLC50125A1
	SMI 双工 用于 980/1000um POF*,压接  SMI Duplex for 980/1000um POF*, crimping or crimping	KZSMA1000A1

所有组件都可以提供固定式防尘帽/All assemblies can be supplied with captive dust protection caps.

根据要求提供其他版本/Other versions on request

\*POF=聚合物/\*POF=Polymer

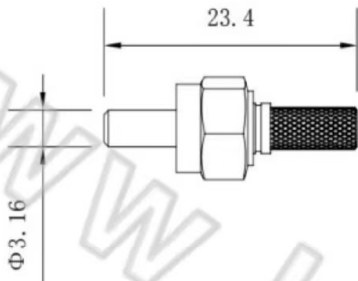
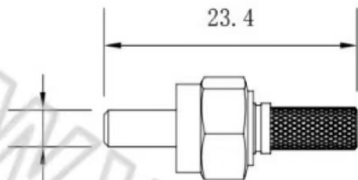
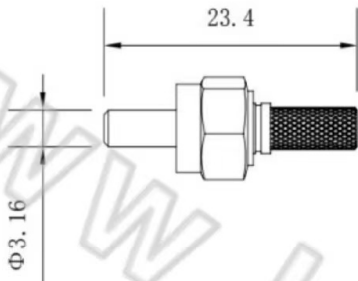
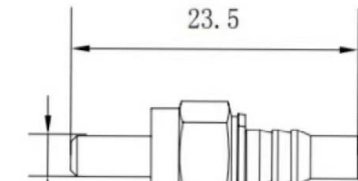
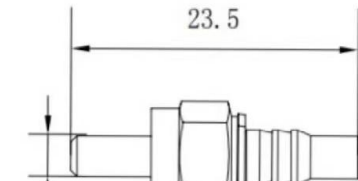
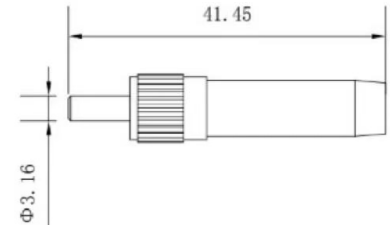

	<p>SMA 单工 用于200/230um HPCS*, 粘贴</p> <p>SMA Simplex, For 200/230um HPCS*, pasting</p>	<p>KZSMA200230A1</p>
	<p>SMA 单工 用于 405um POF*, 粘贴</p> <p>SMA Simplex, for 405um POF*, crimping or pasting</p>	<p>KZSMA405A1</p>
	<p>SMA 单工 用于 610um POF*, 粘贴</p> <p>SMA Simplex, for 610um POF*, crimping or pasting</p>	<p>KZSMA610A1</p>
	<p>SMA 单工 用于1000um POF*, 压接</p> <p>SMA Simplex, for 1000um POF*, crimping or crimping</p>	<p>KZSMA1000A1</p>
	<p>SMA 单工 用于 1500um POF*, 压接</p> <p>SMA Simplex, for 1500um POF*, crimping or crimping</p>	<p>KZSMA1500A1</p>
	<p>SMA 单工 用于 2000um POF*, 粘贴</p> <p>SMA Simplex, for 2000um POF*, crimping or pasting</p>	<p>KZSMA2000A1</p>

所有组件都可以提供固定式防尘帽/All assemblies can be supplied with captive dust protection caps.

根据要求提供其他版本/Other versions on request

\*POF=聚合物/\*POF=Polymer

MOST连接器 MOST Connectors for POF		
简图/Dimension	描述 / Description	Art.-No.
	<p>MOST 单工 用于 1355532um POF*, 压接</p> <p>MOST Simplex, For 1355532um POF* , crimping</p>	KZMOST1355532
	<p>MOST 单工 用于 1355868-2um POF*, 压接</p> <p>MOST Simplex For 1355868-2um POF* , crimping</p>	KZMOST1355868-2
	<p>MOST 单工 用于 1355426um POF*, 压接</p> <p>MOST Simplex, Fo r 1355426um POF* , crimping</p>	KZMOST1355426

所有组件都可以提供固定式防尘帽/All assemblies can be supplied with captive dust protection caps.  
根据要求提供其他版本/Other versions on request

\*POF=聚合物/\*POF=Polymer

传感连接器 传感连接器 Connectors for POF		
简图/Dimension	描述 / Description	Art.-No.
	PRD-B1POF 单工 用于1000um POF*, 压接  PRD-B1POF Simplex, For 320um POF*, crimping	PRD-320-B1POF
	光纤连接器 双工 用于16芯250um * 1芯1000um POF*, 压接  Fiber optic connector Duplex For 16 core OD: 250um * 1core OD:1000um POF*, crimping	KZCG16250A1
	双工 用于 980/1000um POF*压接  Duplex for 980/1000um POF, crimping or crimping	KZ35FAPOFA1
	双工 用于 980/1000um POF*压接  Duplex for 980/1000um POF, crimping or crimping	KZ35FAPOFA2

所有组件都可以提供固定式防尘帽/All assemblies can be supplied with captive dust protection caps.

根据要求提供其他版本/Other versions on request

\*POF=聚合物/\*POF=Polymer

传感连接器 传感连接器 Connectors for POF		
简图/Dimension	描述 / Description	Art.-No.
	FT-49 单工 用于 1000um POF*, 压接  FT Simplex, For 1000um POF*, crimping	KZFT49A1
	FD-66 双工 用于1000um POF*, 压接  FD-66 Duplex For 1000um POF*, crimping	KZFD66A1
	FD-45 双工 用于 8芯 1050um POF*, 压接  FD-45 Duplex, For 8 core OD: 1050um POF*, crimping	KZFD45G8A1
	AF-5 单工 用于 500um POF*, 压接  AF-5 Simplex, For 500um POF*, crimping	KZAF5A1
	AF-5 单工 用于 500um POF*, 压接  AF Simplex, For 500um POF*, crimping	KZAF5A2

所有组件都可以提供固定式防尘帽/All assemblies can be supplied with captive dust protection caps.

根据要求提供其他版本/Other versions on request

\*POF=聚合物/\*POF=Polymer

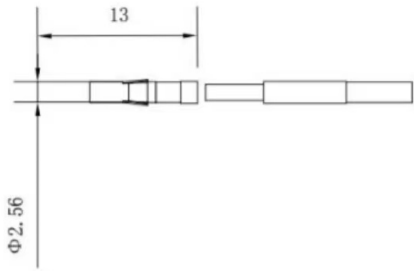
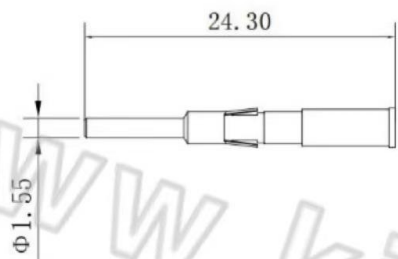
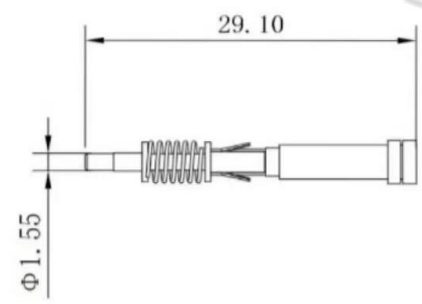
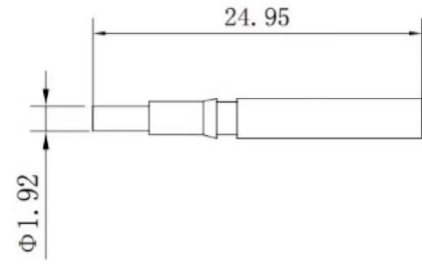
<b>RCPOF1000B</b> <b>RCPOF1000B connectors for POF&amp; HPCS</b>		
	用于SOURIAU RCPOF1000B POF*, for 1/2.2mm POF*, crimping or pasting	KZRCPOF1000B-01
	用于SOURIAU RCPOF1000s POF*, for 1/2.2mm POF*, crimping or pasting	KZRCPOF1000S-01
	用于R15 male F.0.1mmPOF* (U.D):20 10 001 3212 POF*, for 1/2.2mm POF, crimping or pasting	R15 male F.0.1mmPOF
	RMPOF1000 单工 用于 1/2.2mm POF*, 压接或粘贴  RMPOF1000 Simplex for 1/2.2mm POF, crimping or pasting	KZRCPOF1000B-02

所有组件都可以提供固定式防尘帽/All assemblies can be supplied with captive dust protection caps.

根据要求提供其他版本/Other versions on request

\*POF=聚合物/\*POF=Polymer

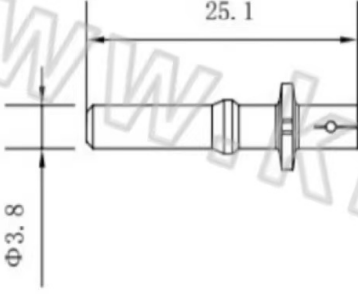
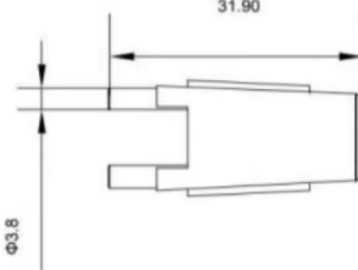

<b>V-Pin</b> <b>V-Pin connectors for POF</b>		
	V-Pin Connectors (Black) 单工 用于 200 230um POF*压接  V-Pin Connectors (Black) Simplex, For 200 230um POF*,crimping	V-Pin200230A1
	Connectors (Black) 单工 用于 400 430um POF*压接  V-Pin Connectors (Black) Simplex, For 400 430um POF*,crimping	V-Pin400430A1
	Connectors ((Blue) 单工 用于 200 230um POF*压接  V-Pin Connectors (Blue) Simplex, Fo 200 230um POF*,crimping	V-Pin200230A2
	Connectors ((Blue) 单工 用于 400 430um POF*压接  V-Pin Connectors (Blue) Simplex, For 400 430um POF*,crimping	V-Pin400430A2
	V-Pin-HPCS ConnectorI 双工 用于200 230um POF*压接  V-Pin-HPCS Connector for 200 230um POF, crimping or crimping	V-Pin-HPCS-D-A1

所有组件都可以提供固定式防尘帽/All assemblies can be supplied with captive dust protection caps.

根据要求提供其他版本/Other versions on request

\*POF=聚合物/\*POF=Polymer

<b>V-Pin</b>		
<b>V-Pin connectors for POF&amp; HPCS</b>		
	HFBR-4501Z 单工 用于1000um POF*压接  HFBR-4501Z Simplex, For 1000um POF*,crimping	HFBR-4501Z
	HFBR-4511Z 单工 用于1000um POF*压接  HFBR-4511Z Simplex, For 1000um POF*,crimping	HFBR-4511Z
	HFBR-4503Z 单工 用于1000um POF*压接  HFBR-4503Z Simplex, For 1000um POF*,crimping	HFBR-4503Z
	HFBR-4513Z 单工 用于1000um POF*压接  HFBR-4513Z Simplex, For 1000um POF*,crimping	HFBR-4513Z
	HFBR-4506Z 双工 用于 for 1/2.2mm POF*粘贴  HFBR-4506Z Duplex, For 1/2.2mm POF*, pasting	HFBR-4506Z
	HFBR -4516Z 双工 用于 1/2.2mm POF*粘贴  HFBR-4516Z Duplex, For 1/2.2mm POF*, pasting	HFBR-4516Z

所有组件都可以提供固定式防尘帽/All assemblies can be supplied with captive dust protection caps.

根据要求提供其他版本/Other versions on request

\*POF=聚合物/\*POF=Polymer

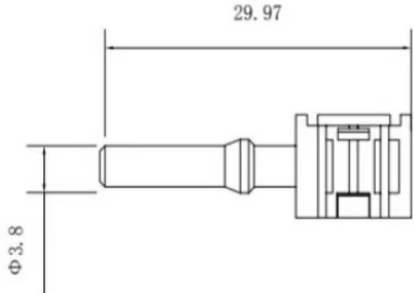
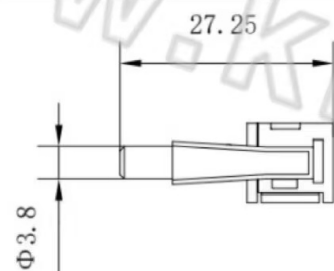
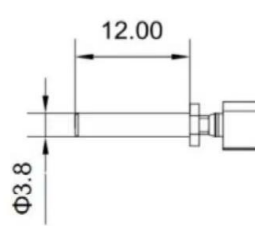
<b>V-Pin</b>		
<b>V-Pin connectors for POF</b>		
	HFBR-4531Z 单工 用于 1000um POF*压接  HFBR-4531Z Simplex, For 1000um POF*,crimping	HFBR-4531Z
	HFBR-4533Z 单工 用于 1000um POF*压接  HFBR-4533 Simplex, For 1000um POF*,crimping	HFBR-4533Z
	HFBR-4535Z 单工 用于 1000um POF*压接  HFBR -4535Z Simplex, For 1000um POF*,crimping	HFBR-4535Z
	HFBR-4532Z 单工 用于 1000um POF*压接  HFBR-4532Z Simplex, For 1000um POF*,crimping	HFBR-4532Z
	AFBR-S10PS010Z 用于光弧闪光检测的点传感器  AFBR-S10PS010Z Point sensor for optical arc flash detection	AFBR-S10PS010Z
	AFBR-S10PS011Z 用于点传感器的塑料光纤连接器  AFBR-S10PS011Z lastic Optical Fiber Connector for Point Sensor	AFBR-S10PS011Z

所有组件都可以提供固定式防尘帽/All assemblies can be supplied with captive dust protection caps.

根据要求提供其他版本/Other versions on request

\*POF=聚合物/\*POF=Polymer

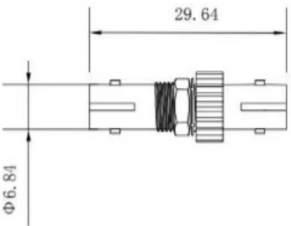
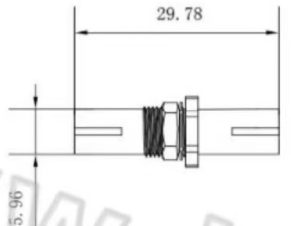
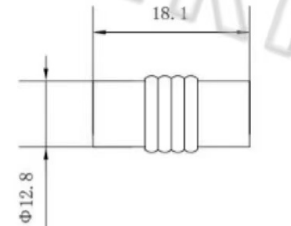
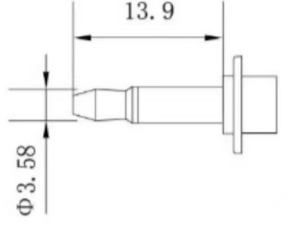
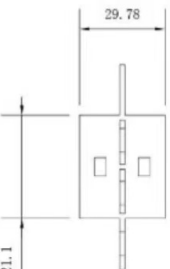
适配器 适配器 connectors for POF		
	HFBR 单工 用于4505Z-POF*压接 HFBR Simplex, For4505Z-POF*,crimping	HFBR-4505Z
	HFBR 单工 用于4515Z-POF*压接 HFBR Simplex, For4515Z-POF*,crimping	HFBR-4515Z
	SPQ 单工 用于4503Z-4513POF*压接  SPQ Simplex, For4503Z-4513POF*,crimping	KZSPQ4503A1
	适配器 单工 用于F05-F05POF*压接  SPQ Simplex, ForF05-F05POF*,crimping	KZSPQF05A1
	适配器 单工 用于F05-mimiPOF*压接  SPQ Simplex, ForF05-mimiPOF*,crimping	KZSPQF05A2
	适配器 双工 用于F07-F07POF*压接  SPQ Simplex, ForF07-F07POF*,Duplex	KZSPQF07A1

所有组件都可以提供固定式防尘帽/All assemblies can be supplied with captive dust protection caps.

根据要求提供其他版本/Other versions on request

\*POF=聚合物/\*POF=Polymer

适配器 适配器 connectors for POF		
	<p>塑料光纤分路器1分2 用于 1/2.2mm POF*, 压接</p> <p>Plastic fiber seminars 1 point 2 Used for 1/2.2mm pof*, pressing</p>	<p>KZFLQ1T2A1</p>
	<p>塑料光纤分路器1分3 用于 F05 1分3 POF*压接</p> <p>Plastic fiber seminars 1 point 3 Used for 1/2.2mm pof*, pressing</p>	<p>KZFLQ1T3A1</p>
	<p>塑料光纤分路器1分4 用于 F05 1分4 POF*压接</p> <p>Plastic fiber seminars 1 point 4 Used for 1/2.2mm pof*, pressing</p>	<p>KZFLQ1T4A1</p>

所有组件都可以提供固定式防尘帽/All assemblies can be supplied with captive dust protection caps.

根据要求提供其他版本/Other versions on request

\*POF=聚合物/\*POF=Polymer

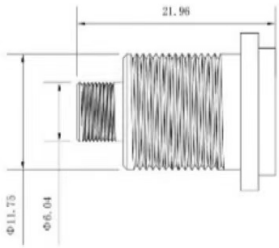

收发座子 收发座子 connectors for HPCS&POF		
	<p>SMA母座 单工 配有配件：附件螺母，锁紧架，用于PCB附件的附件螺钉和防尘盖</p> <p>SMA female connector Simplex, Complete with accessories: attachment nut, lockwasher, attachment screws for PCB attachment and dust cap</p>	KZ-SMA-TRA1
	<p>SMA探头 单工 配有配件：附件螺母，锁紧架，用于PCB附件的附件螺钉和防尘盖</p> <p>SMA Probe Connector Simplex, Complete with accessories: attachment nut, lockwasher, attachment screws for PCB attachment and dust cap</p>	KZ-SMA-TRA2

所有组件都可以提供固定式防尘帽/All assemblies can be supplied with captive dust protection caps.  
 根据要求提供其他版本/Other versions on request

\*POF=聚合物/\*POF=Polymer